

ANTENNAS | DASH SERIES, SMART METER ANTENNA

DASH-1

ULTRA LOW PROFILE SMART METER ANTENNA, 690MHZ – 2700MHZ

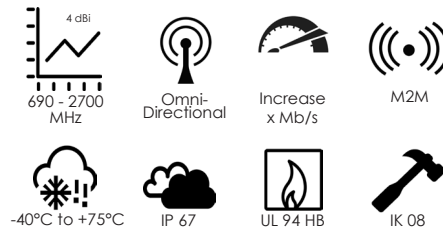

- Smart Meter, M2M, IoT antenna
- Futureproof wideband LTE antenna
- Backwards compatible with 3G and 2G technologies
- Increased connectivity stability

Product Overview

The DASH-1 antenna is purposefully designed for low profile requirements such as Smart Meters. This omni-directional antenna is suitable for indoor and outdoor use, typically mounted on the top or side of smart meter boxes. The DASH-1 antenna is designed with installation simplicity in mind, while covering the LTE frequency bands 690 – 2700MHz. This antenna has a superior electrical performance over the whole 690 - 2700MHz LTE/cellular bands.

Features

- Omni-directional antenna
- Wideband - covers wide frequency band
- Easy installation
- Stylish, but robust design
- Weather & vandal resistant

M2M and IoT Application areas

- Smart Utilities: Smart Power Metering, Gas & Water Metering
- Smart Buildings: Climate control, access control, security, irrigation
- Digital Signage
- Smart Environmental & Water Systems
- Warehouses & Logistic systems
- Industrial factory automation and M2M systems
- Farming & Agricultural M2M & IoT

Can be used with the following IoT technologies:

- | | |
|-----------|----------------|
| • Zigbee | • Wi-Fi |
| • Z-Wave | • Wi-Fi HaLow |
| • LoRaWAN | • LTE-M/NB-IoT |
| • Sigfox | • Bluetooth |



Frequency bands

The DASH-1 works across the following LTE bands: 1-21, 23-28, 30, 33-41

 Indicates the bands on which this antenna works

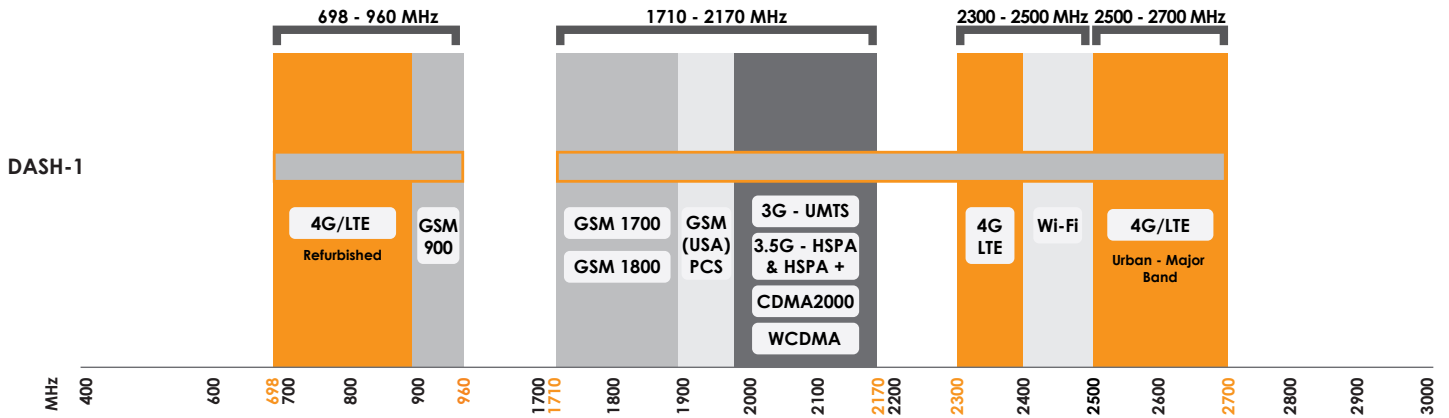

Antenna Performance Plots

VSWR:

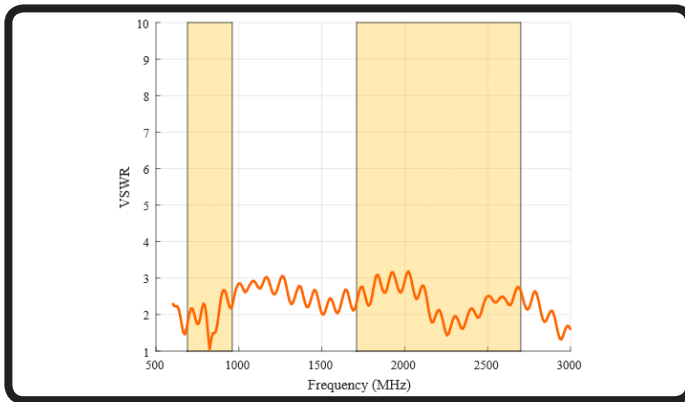

Voltage Standing Wave Ratio (VSWR)

VSWR is a measure of how efficiently radio-frequency power is transmitted from a power source, through a transmission line, into a load. In an ideal system, 100% of the energy is transmitted which corresponds to a VSWR of 1:1. The DASH-1 delivers superior performance across all bands with a VSWR of 2.5:1 or better across 90% of the band.

Gain : (excluding cable loss)

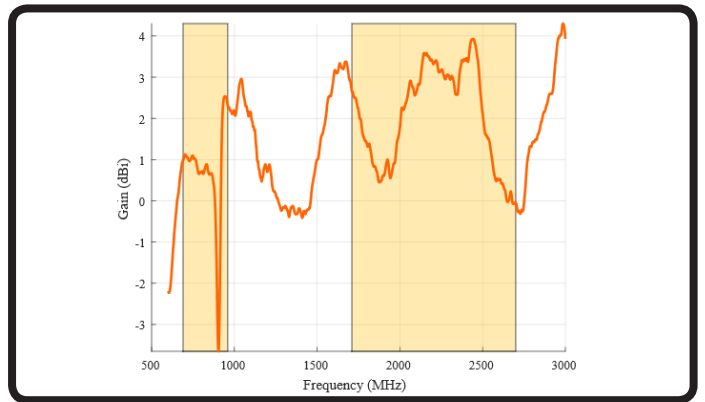

Gain* in dBi

4 dBi is the peak gain across all bands from 698 - 2700 MHz

Gain @ 690 - 960 MHz:

1 dBi

Gain @ 1710 - 2700 MHz:

4 dBi

*Antenna gain measured with polarisation aligned standard antenna

Radiation Patterns - Antenna mounted vertically

Elevation: 690 - 960 MHz (side view)

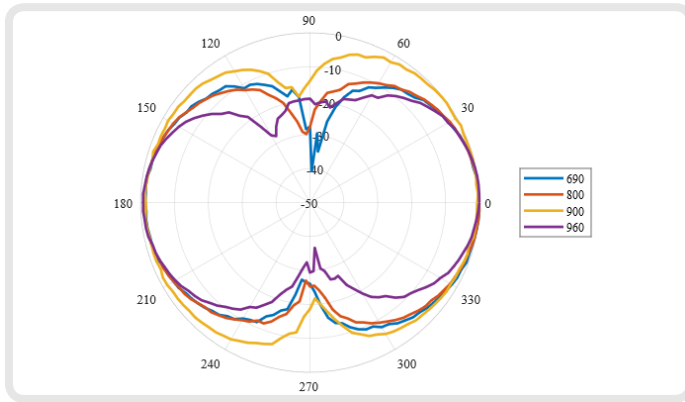

Elevation: 1710 - 2700 MHz (side view)

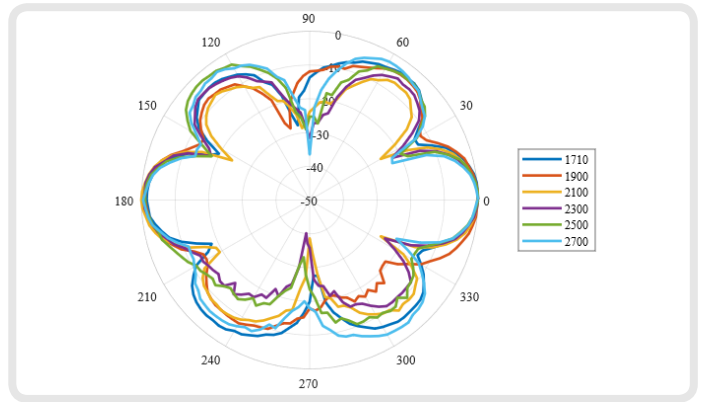

Azimuth: 690 - 960 MHz (top view)

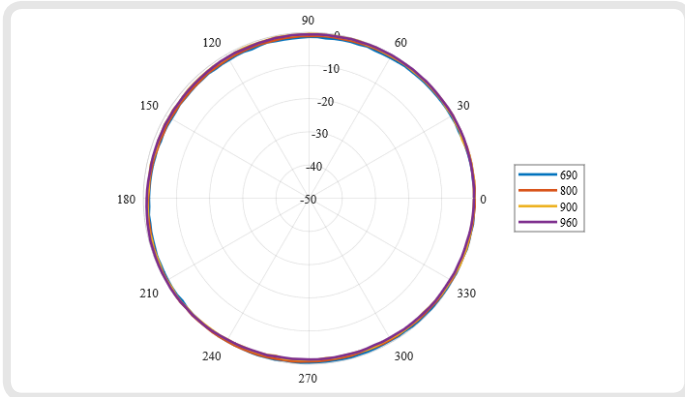

Azimuth: 1710 - 2700 MHz (top view)

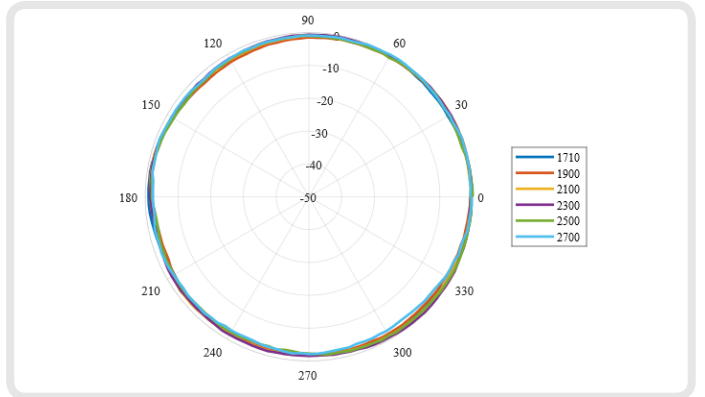

Electrical Specifications

Operating Frequency:	690 - 2700 MHz
Gain (Max):	4 dBi
VSWR:	< 2.5:1 over 95% of the band
Feed Power Handling:	10 W
Input impedance:	50 Ohm (nominal)
Polarisation:	Linear Horizontal / Vertical (installation dependent)
Cable loss:	1dB/m @ 900 MHz
Cable:	RG 174
Cable length:	1m ±5%
Connector:	Right Angle MCX
DC Short:	Yes

Mechanical Specifications

Product Dimensions (L x W x D):	258mm x 34mm x 13mm
Packaging Material:	Poly bag
Packaged Dimensions:	265mm x 100mm x 15mm
Weight:	60g
Packaged Weight:	70g
Radome Material:	ABS/PC (Halogen Free)
Radome Colour:	Pantone Black or Cool Gray 1C
Mounting:	Adhesive backing & M8 x 17mm spigot with M8 brass nut

Environmental Specifications

Wind Survival:	160 km/h
Temperature Range (Operating):	-40°C to +75°C
Environmental Conditions:	IP67 (excl. Spigot Mounting)
Operating Relative Humidity:	Up to 98%
Storage Humidity:	5% to 95% non-condensing
Storage Temperature:	-40°C to +75°C

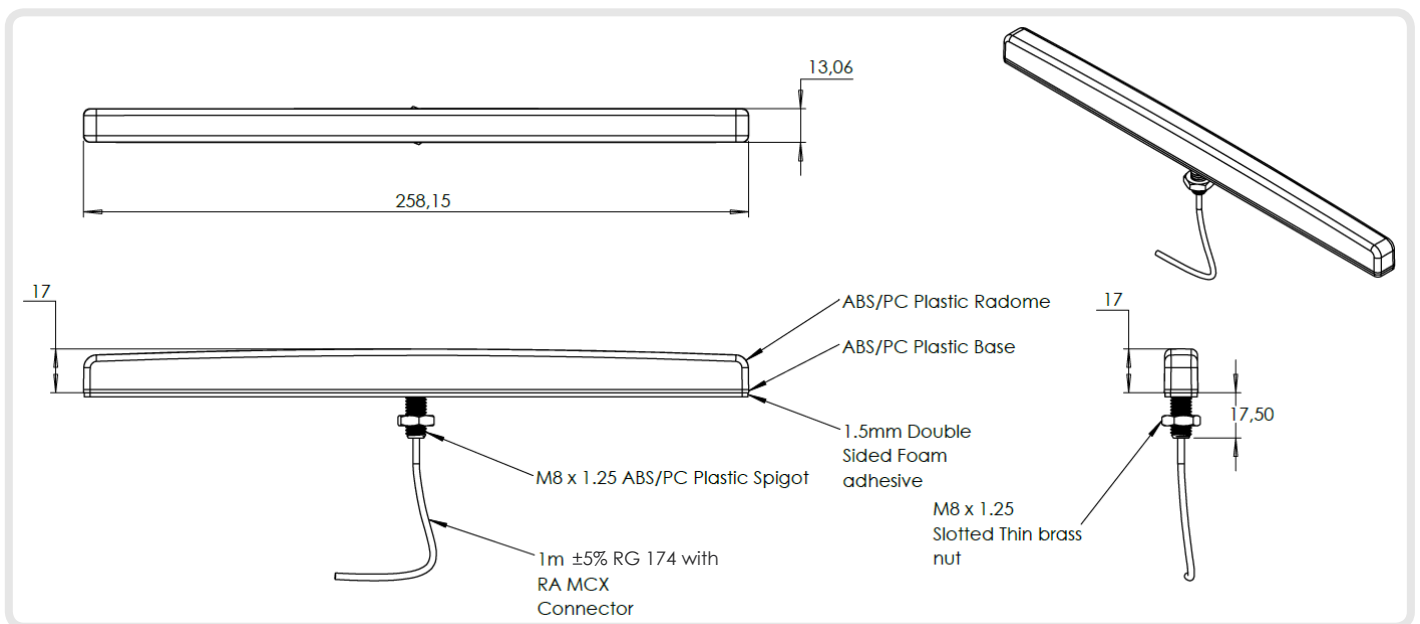

Certification Approvals and Standards

Cable Flammability rating:	UL 94-HB
Water Ingress Protection Ratio/Standard:	IP 67 (NEMA 4X)
Impact resistance:	IK 08
Salt Spray:	MIL-STD 810F/ASTM B117
Product Safety:	Complies with UL, CE, EN, CSA and IEC standards

Ordering Information

Commercial name:	DASH-1
Order Product Code:	A-DASH-0001-V1
EAN number:	0707273470010



For more detailed information and availability in your region, visit our web site: www.poynting.tech

Contact Poynting

Poynting Antennas (Pty) Ltd - Head Office

Unit 4, N1 Industrial Park
Landmarks Avenue,
Samrand, 0157
South Africa

Phone: +27 (0) 12 657 0050

E-mail: sales@poynting.co.za

Poynting Europe

Regus Business Center Neue Messe Riem
Kronstadler Straße 4
81677 München
Germany

Phone: +49 89 208026538

E-mail: sales-europe@poynting.tech

DASH-1

©2018 Poynting Antennas (Pty) Ltd. All rights reserved.
Product Specifications may change without prior notice
Revised: March 2018