

NDM-7702-AL Fixed dome 12MP 3.7-7.7mm IP66 IR

FLEXIDOME multi 7000i IR



- ▶ Four 3 MP imagers at 30 fps in one camera on a single IP address
- ▶ Easy and flexible installation with four motorized zoom/focus lenses
- ▶ High Dynamic Range (HDR) to see every detail in both bright and dark areas of the scene
- ▶ Built-in Intelligent Video Analytics to trigger relevant alerts and quickly retrieve data
- ▶ Integrated surround IR illumination up to 30 m distance for pitch dark scenes

The FLEXIDOME multi 7000i IR camera is built for high-quality performance, featuring four independent imagers with motorized zoom/focus lenses. It helps to simplify installation and lower costs while maintaining flexibility in coverage. With four scenes simultaneously in a single camera, it is perfect for wide area coverage, traffic intersections and building corners. With its integrated 360° IR lighting, the camera can capture crisp images in extremely low light conditions, such as at night-time or dusk. When the lenses are tilted at the right angle, the camera can even cover an area up to full 360°. Additionally, the zoom capability allows the camera to obtain detailed coverage for more distant areas.

Functions

12-megapixel multi-directional overviews

Four independent 3-megapixel imagers with separate remote zoom and focus lenses capture very high-quality images with a total resolution of 12 megapixels.

Each of the four imagers can be set-up flexibly with 3-axis movement along a circular track. This enables surround coverage, capturing detailed images from every angle for comprehensive video coverage with four separate views from a single IP address.

High Dynamic Range

The camera has High Dynamic Range. This is based on a multiple-exposure process that captures more details in the highlights and in the shadows even in

the same scene. The result is that you can easily distinguish objects and features, for example, faces with bright backlight.

The actual dynamic range of the camera is measured using Opto-Electronic Conversion Function (OECF) analysis according to IEC 62676 Part 5. This method is used to provide standardized measurements, which can be used to compare different cameras.

H.265 high-efficiency video encoding

The camera is designed on the most efficient and powerful H.264 and H.265/HEVC encoding platform. The camera is capable of delivering high-quality and high-resolution video with very low network load. With a doubling of encoding efficiency, H.265 has become the new compression standard of choice for IP video surveillance systems.

Two-way audio and built-in microphone

Two-way audio allows the operator to communicate with visitors or intruders via an external audio line input and output. Alternatively, there is an integrated microphone to capture crisp and clear audio. By using the integrated or external microphone, audio detection can be used to generate alarms to alert the security operator quicker and act more proactively. If required by local laws, the microphone can be blocked via a secure license key.

Intelligent Video Analytics

The camera uses the latest generation of Bosch Intelligent Video Analytics (IVA).

Specifically designed for the most demanding environments. It is extremely resistant to false triggers caused by challenging environments with snow, wind (moving trees), rain, hail, and water reflections.

By using the zoom function of the lens, the camera can provide automatic person detection over distances up to 130 m / 430 ft.

The system reliably detects, tracks, and analyzes objects, and alerts you when predefined alarms are triggered. A smart set of alarm rules makes complex tasks easy and reduces false alarms to a minimum. Intelligent Video Analytics also adds sense and structure to your video by adding metadata.

Calibration is quick and easy - just enter the height of the camera. The internal gyro/accelerometer sensors provide the rest of the information to precisely calibrate the video analytics for each imager.

The next step in video analytics is taken with the incorporation of machine learning capabilities. With Camera Trainer you can tailor the built-in Intelligent Video Analytics to detect new user-defined moving or stationary objects and situations, or any subsequent changes.

DORI coverage

DORI (Detect, Observe, Recognize, Identify) is a standard system (EN-62676-4) for defining the ability of a person viewing the video to distinguish persons or objects within a covered area. The maximum distance at which a camera/lens combination can meet these criteria is shown below:

12 MP camera with 3.7 - 7.7 mm lens*

DORI	DORI definition	Distance 3.7 mm/7.7 mm	Horizontal width
Detect	25 px/m (8 px/ft)	45 m/117 m (148 ft/384 ft)	82 m (256 ft)
Observe	63 px/m (19 px/ft)	18 m/46 m (59 ft/151 ft)	33 m (108 ft)
Recognize	125 px/m (38 px/ft)	9 m/23 m (31 ft/75 ft)	16 m (54 ft)
Identify	250 px/m (76 px/ft)	4 m/12 m (13 ft/39 ft)	8 m (27 ft)

*The numbers in this table do not reflect IVA distances. For IVA distances, refer to the lens calculator / Bosch IP video design tool.

Scene modes

Multiple configurable modes are provided with the best settings for a variety of applications. In one click fully optimized image settings can be selected to suit the conditions. Different scene modes can be selected for different situations such as sodium lighting, fast moving objects, or dark environments.

Resists rain, dust, and tampering with reliable operation across a wide temperature range

Suitable for indoor and outdoor usage.

The robust design of the camera is rated to IP66 and IK10 standards, safeguarding the camera against rain and dust while also offering protection against vandalism and tampering.

The camera can operate in a wide ambient temperature range between -50 °C up to +55 °C / -58 °F up to 131 °F.

Easy installation

With the multi-imager camera, it is only necessary to install one camera, pull one cable, configure one IP address, and acquire one video management software (VMS) license (applicable for most common VMS, including BVMS 11.1 or higher), while having the benefit of using four cameras.

The mechanical design follows the Bosch installation philosophy by using an installation mount plate and easy cable management.

Power can be supplied via Power-over-Ethernet. With this configuration, only a single cable connection is required to view, power, and control the camera. Using PoE makes installation easier and more cost-effective, as cameras do not require a local power source.

Modular accessories

A full line of modular accessories is available that allows a consistent design across different cameras and a wide range of installation possibilities. Available options include wall or pipe mount, a surveillance cabinet with power and fiber optic options, and an in-ceiling mounting kit. There is also a conduit adapter available for installations on concrete walls or ceilings.

Data security

Special measures have been put in place to ensure the highest level of security for device access and data transport. The three-level password protection with security recommendations allows users to customize device access. Web browser access can be protected using HTTPS and firmware updates can also be protected with authenticated secure uploads. The cameras have built-in Secure Element (SE) hardware providing main Trusted Platform Module (TPM) functionality to ensure the highest levels of data security and privacy protection. Together with Public Key Infrastructure (PKI) support, superior protection from malicious attacks is guaranteed. It also supports 802.1x network authentication with EAP/TLS and RSA encryption key lengths of up to 4096 bits, ensuring data safety beyond 2030. The advanced certificate handling offers:

- Bosch origin device certificate pre-installed
- Self-signed unique certificates automatically created when required
- Client and server certificates for authentication
- Client certificates for proof of authenticity

- Certificates with encrypted private keys
- Bosch origin device certificate pre-installed

Edge recording

Insert a memory card into the card slot to store up to 2 TB of local alarm recording. Pre-alarm recording in RAM reduces recording bandwidth on the network, and extends the effective life of the memory card. It has advanced edge recording providing a reliable storage solution possible due to the combination of these functions:

- Industrial SD card support allows for extreme lifetime
- Health monitoring of industrial SD cards provide early service indications.

System integration and ONVIF conformance

The camera conforms to the ONVIF Profile S, ONVIF Profile G, ONVIF Profile M, and ONVIF Profile T specifications. For H.265 configuration, the camera supports Media Service 2, which is part of ONVIF Profile T. Compliance with these standards guarantees interoperability between network video products regardless of manufacturer. Third-party integrators can easily access the internal feature set of the camera for integration into large projects. Visit the Bosch Integration Partner Program (IPP) website (ipp.boschsecurity.com) for more information.

Cloud-based services

The camera supports time-based or alarm-based JPEG posting to four different accounts. These accounts can address FTP servers or cloud-based storage. Video clips or JPEG images can also be exported to these accounts.

Alarms can be set up to trigger an e-mail or SMS notification so you are always aware of abnormal events.

Bosch Remote Portal

With the secure cloud infrastructure, Bosch Remote Portal, you can manage your connected Bosch devices. From the Bosch Remote Portal you can:

- Complete initial configuration of your connected Bosch devices (online or offline).
- Update firmware for single or multiple devices.
- Manage certificates.
- Monitor the health of your connected Bosch devices.

Project Assistant app

As the camera is equipped with a USB-C port for a wireless USB dongle (sold separately: NCA-WLAN-EU, NCA-WLAN-NA), the installer can easily perform the initial configuration wirelessly. Using a mobile device with the Bosch Project Assistant app, you can do initial set-up and lens zoom-focus to find the right scene. Simply connect the wireless USB dongle and go to the Bosch Project Assistant app, available for iOS, Windows, or Android.

Regulatory information

Standard	Type
Emission	EN 55032 (Class A) CFR 47 FCC part 15 (Class A)
Immunity	EN-50121-4 EN 50130-4
Environmental	EN50130-5, Class IV, Fixed equipment, Outdoor in general EN IEC 63000: 2018 RoHS EU, 2011/65/EU and 2015/863/EU WEEE EU, 2012/19/EU
Safety	EN 62368-1 EN 60950-22 UL 62368-1 and UL 60950-22 IEC 62368-1 and IEC 60950-22 CAN/CSA-C22.2 No. 62368-1-14 CAN/CSA-C22.2 No. 60950-22-17
Image performance	IEC 62676-5
ONVIF conformance	EN 50132-5-2, EN 62676-2
Impact protection	EN 62262 (IK10)
Ingress protection	EN 60529 (IP66) and UL50E (NEMA Type 4X)
Marks	CE, FCC, UL, WEEE, RCM, VCCI, CMIM, UKCA, China RoHS, EAC, BIS
IR lighting	IEC 62471

Region	Regulatory compliance/quality marks	
Europe	CE	FLEXIDOME multi 7000i IR
Great Britain	UKCA	FLEXIDOME multi 7000i IR
Global	IEC 62443	Industrial Cyber Security Capability
USA	UL CAP	Cybersecurity Assurance Program

Installation/configuration notes

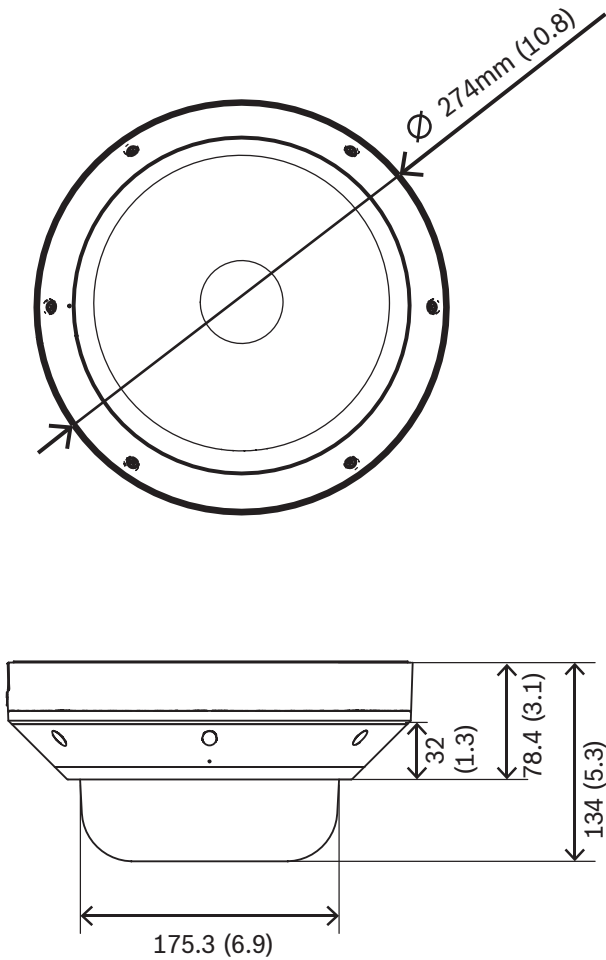

Dimensions in mm (inch)

Parts included

Quantity	Component
1	Camera
1	Mounting plate
1	RJ-45 punch-through aid
1	TR20 Allen key
1	2-pin power connector
1	8-pin Audio and I/O connector
2	M20 rubber grommets
1	Quick installation guide

Quantity	Component
1	Safety information
3	Installer UX labels

Technical specifications

Power	
Input voltage	PoE+ 802.3at Type 2 Class 4 with operating temperature -20 °C to +55 °C (-4 °F to +131 °F) PoE++ 802.3bt Type 3 Class 5 with operating temperature -50 °C to +55 °C (-58 °F to +131 °F) 24 VAC ±10% PoE and auxiliary power can be connected simultaneously for redundant operation
Power Consumption (typical / maximum)	PoE+: 10.6 W / 21.8 W (without heater) PoE++: 10.6 W / 42.3 W 24 VAC: 9.2 W / 36.1 W

Sensor	
Sensor type	4x 1/2.7-inch CMOS

Sensitivity	
Measured according to IEC 62676 Part 5 (1/25, F1.9)	
Color	0.091 lx
Mono	0.012 lx
With IR	0 lx

Dynamic range	
High Dynamic Range	120 dB WDR
HDR Measured according to IEC 62676 Part 5	101 dB WDR

Night vision	
Distance	30 m (98 ft)
LED	360° LED high efficiency array, 850 nm
IR intensity	Adjustable

Optical	
Lens	3.7 - 7.7 mm F1.9
Adjustment	Motorized zoom/focus
Day/Night	Switchable IR-cut filter

Optical	
Viewing angle	Wide: 85.1° x 62° (H x V) Tele: 38.7° x 29.0° (H x V)
Viewing angle (maximum combined)	Up to 360° coverage (depending on lens position and tilt)
Platform	
Common product platform	CPP14.1
Video streaming	
Video compression	H.265; H.264; M-JPEG
Streaming	Multiple configurable streams in H.264, H.265 and M-JPEG, configurable frame rate and bandwidth. Regions of Interest (ROI)
Camera latency	120 ms
GOP structure	IP
Frame rate	1-30 fps
Signal-to-Noise Ratio (SNR)	>55 dB
Video resolution (H x V)	
Max. resolution	4x 2048 x 1536 (4:3) @30 fps 4x 1920 x 1080 (16:9) @30 fps
Max. resolution corridor mode	4x 1536 x 2048 (3:4) @30 fps 4x 1080 x 1920 (9:16) @30 fps
Multiple lower resolutions available in 4:3 and 16:9 format individually selectable per stream and imager	
Image setup	
Mirror image	On / Off
Rotate image	0° / 90° / 180° / 270°
Positioning	Coordinates / Mounting height
Video functions	
White Balance	2300 to 10000K, 3 automatic modes (Basic, Standard, Sodium vapor), Manual mode and Hold mode
Shutter	Automatic Electronic Shutter (AES); Fixed shutter (1/25[30] to 1/15000) selectable; Default shutter

Video functions	
Day/Night	Auto (adjustable switch point), Color, Monochrome
Noise reduction	Dynamic noise reduction with 3 levels: Low, Medium and High
Scene modes	Standard, Sodium lighting, Sensitivity boost, Backlight, Vibrant, Color only
Privacy Masking	Eight independent areas per imager, fully programmable
Display stamping	Name; Logo; Time; Alarm message; fully programmable per imager
Additional functions	Contrast, Saturation level and control, Brightness, Sharpness, ALC level, Defog
Video content analysis	
Analysis type	Intelligent Video Analytics, Camera Trainer
Alarm rules (combined)	Any object, Object in field, Line crossing, Enter / leave field, Loitering, Follow route, Idle / removed object, Counting, Occupancy, Crowd density estimation, Condition change, Similarity search, Flow / counter flow
Number of rules (simultaneously)	16 per imager
Object filters	Duration, Size, Aspect ratio, Speed, Direction, Color, Object classes (4)
Tracking modes	Standard (2D) tracking, 3D tracking, 3D people tracking, Ship tracking, Museum mode
Object classes	Person, car, bike, truck
Calibration / Geolocation	Automatic, based on gyro sensor, focal length and camera height
Additional functions	Tamper detection
Local storage	
Internal RAM	5 s pre-alarm recording
Memory card slot	Micro SDXC / SDHC / SD card
Industrial SD cards	Extreme lifetime and health monitoring support (if supported by the SD card) that provides early service indication.
Input/output	
Audio line in	0.6 Vrms, 40 kOhm

Input/output	
Audio line out	1.0 Vrms, 10 kOhm
Microphone	1 integrated microphone (can be disabled)
Alarm input	1 input
Alarm input activation	Short or DC 5V activation
Alarm output	1 output
Alarm output voltage	30 VDC, max. load 0.5 A
Ethernet	RJ-45
USB	USB 2.0 Type C, for use with wireless USB dongle for setup and commissioning (sold separately, available 2023)
Fiber optics (sold separately)	The Fiber Optic Ethernet Media Converter kit (VG4-SFPSCKT) installed inside a Surveillance Cabinet (NDA-U-PA0, NDA-U-PA1 or NDA-U-PA2) provides the fiber optic interface to the mounted camera.

Audio streaming	
Standard	G.711, 8 kHz sampling rate L16, 16 kHz sampling rate AAC-LC, 48 Kbit/s at 16 kHz sampling rate AAC-LC, 80 Kbit/s at 16 kHz sampling rate
Signal-to-Noise Ratio	>50 dB
Audio Streaming	Full-duplex / half duplex

Network	
IP	One IP address for all four imagers
Protocols	IPv4, IPv6, UDP, TCP, HTTP, HTTPS, RTP/RTCP, IGMP V2/V3, ICMP, ICMPv6, RTSP, FTP, ARP, DHCP, APIPA (Auto-IP, link local address), NTP (SNTP), SNMP (V1, V3, MIB-II), 802.1x, DNS, DNSv6, DDNS (DynDNS.org, selfHOST.de, no-ip.com), SMTP, iSCSI, UPnP (SSDP), Diff-Serv (QoS), LLDP, SOAP, CHAP, digest authentication
Ethernet	10/100/1000 Base-T
Interoperability	ONVIF Profile S; ONVIF Profile G; ONVIF Profile M; ONVIF Profile T

Data security	
Secure Element ("TPM")	RSA 4096 bit, AES/CBC 256 bit

Data security	
PKI	X.509 certificates
Encryption	Full end-to-end encryption with supported VMS Network: TLS1.0/1.1/1.2/1.3, AES128, AES256 Local storage: XTS-AES
Video authentication	checksum, MD5, SHA-1, SHA-256
Firmware protection	Signed firmware, secure boot

Mechanical	
Dimensions (D x H)	275 x 137 mm (10.8 x 5.4 in)
Weight	3.38 kg (7.45 lbs)
Color	White (RAL9003)
Gyrosensor	Yes, 1 per imager
4-axis lens adjustment	Pan: 0° to 360° Rotate: -20° to 20° Tilt: 0° to 105° Roll: -90° to 90°
Dome bubble	Polycarbonate, clear with UV blocking anti-scratch coating
Housing	Aluminum with dehumidifying membrane and waterproof connection area
Mounting	Mounting plate included for surface mount, 4-inch square junction box, single and double gang box
Conduit	3/4-inch NPT (M25) conduit side entry (sold separately)

Environmental	
Operating temperature	PoE++ (with heater): -50 °C to +55 °C (-58 °F to +131 °F) PoE+ (without heater): -20 °C to +55 °C (-4 °F to +131 °F) -34 °C to +74 °C (-30 °F to +165 °F) according to NEMA TS 2-2003 (R2008), para. 2.1.5.1. using fig. 2.1 test profile
Storage temperature	-40 °C to 70 °C (-40 °F to 158 °F)
Cold start temperature	-20 °C (-4 °F)
Operating humidity	5% to 93% RH non condensing 100% RH condensing

Environmental

Storage humidity	Up to 98% RH
Impact protection	IK10
Water/dust protection	IP66 and NEMA Type 4X

Ordering information

NDM-7702-AL Fixed dome 12MP 3.7-7.7mm IP66 IR
12 MP multi-imager camera, four motorized zoom/focus lenses, 30 fps, IVA, H.265, IK10, IP66, integrated IR up to 30 m
NDAA compliant
Order number **NDM-7702-AL | F.01U.389.264**

Accessories

NDA-7050-PIPW Pendant interface plate, 275mm
Pendant interface plate with weather cap for FLEXIDOME multi 7000i IR
Order number **NDA-7050-PIPW | F.01U.394.000**

NDA-7051-CA Conduit adapter M25 for NDM-770*, 5pcs
Conduit adapter for FLEXIDOME multi 7000i and FLEXIDOME multi 7000i IR, 5 pieces
Order number **NDA-7051-CA | F.01U.394.257**

NDA-U-WMT Pendant wall mount
Universal wall mount for dome cameras, white
Order number **NDA-U-WMT | F.01U.324.939**

NDA-U-WMP Wall mount plate
Back plate for universal wall mount, corner mount and pole mount, white, IP66
Order number **NDA-U-WMP | F.01U.324.950**

NDA-U-PMT Pendant pipe mount, 12" (31cm)
Universal pipe mount for dome cameras, 31 cm, white
Order number **NDA-U-PMT | F.01U.324.940**

NDA-U-PMTE Pendant pipe extension, 20" (50cm)
Extension for universal pipe mount, 50 cm, white
Order number **NDA-U-PMTE | F.01U.324.941**

NDA-U-PMTS Pendant pipe mount, 4" (11 cm)
Universal pendant pipe mount for dome cameras, 11 cm (4"), white
Order number **NDA-U-PMTS | F.01U.385.046**

NDA-U-PSMB Pendant wall/ceiling mount SMB
Surface mount box (SMB) for wall mount or pipe mount.
Order number **NDA-U-PSMB | F.01U.324.942**

NDA-U-PMAS Pole mount adapter small
Pole mount adapter small
Universal pole mount adapter, white; small.
Order number **NDA-U-PMAS | F.01U.324.943**

NDA-U-PMAL Pole mount adapter large
Universal pole mount adapter, white; large
Order number **NDA-U-PMAL | F.01U.324.944**

NDA-U-RMT Pendant parapet mount
Universal roof mount for dome cameras, white
Order number **NDA-U-RMT | F.01U.324.945**

NDA-U-CMT Corner mount adapter
Universal corner mount, white
Order number **NDA-U-CMT | F.01U.324.946**

NDA-U-PA0 Surveillance cabinet 24VAC
Surveillance cabinet, 24 VAC input, 24 VAC output, IP66
Order number **NDA-U-PA0 | F.01U.324.947**

NDA-U-PA1 Surveillance cabinet 120VAC
Surveillance cabinet, 100 - 120 VAC 50/60 Hz input, 24 VAC output, IP66
Order number **NDA-U-PA1 | F.01U.324.948**

NDA-U-PA2 Surveillance cabinet 230VAC
Surveillance cabinet, 230 VAC input, 24 VAC output, IP66
Order number **NDA-U-PA2 | F.01U.324.949**

VG4-SFPSCKT Ethernet to SFP interface kit
Ethernet media converter video transmitter/data receiver fiber optic kit for AUTODOME 7000i cameras and for the Surveillance cabinets (NDA-U-PA0, NDA-U-PA1 and NDA-U-PA2).
Order number **VG4-SFPSCKT | F.01U.142.529**

SFP-2 Fiber module, multimode, 1310nm, 2LC
SFP Fiber Optic Module, 2 km (1.2 miles), 2 LC connectors.
Multi-mode
1310 nm
Order number **SFP-2 | F.01U.136.537**

SFP-3 Fiber module, single-mode, 1310nm, 2LC
SFP Fiber Optic Module, 20 km (12.4 miles), 2 LC connectors.
Single-mode
1310 nm
Order number **SFP-3 | F.01U.136.538**

SFP-25 Fiber module, 1310/1550nm, 1SC
SFP Fiber Optic Module, 2 km (1.2 miles), 1 SC connector
Multi-mode
1310/1550 nm
Order number **SFP-25 | F.01U.136.541**

SFP-26 Fiber module, 1550/1310nm, 1SC
SFP Fiber Optic Module, 2 km (1.2 miles), 1 SC connector
Multi-mode
1550/1310 nm
Order number **SFP-26 | F.01U.136.542**

NDA-U-PMTG Pendant pipe mount, gang box
Universal pipe mount, compatible with gang box installation for fixed dome cameras only, white
Order number **NDA-U-PMTG | F.01U.358.359**

NDA-U-WMTG Pendant wall mount, gang box
Universal wall mount, compatible with gang box installation for fixed dome cameras only, white
Order number **NDA-U-WMTG | F.01U.358.358**

NPD-3001-WAP Portable installation tool
Bosch camera portable and wireless installation tool
Order number **NPD-3001-WAP | F.01U.353.329**

NPD-6001C Midspan bt 60W indoor
Indoor midspan with Power-over-Ethernet for use with PoE-enabled cameras; 60 W, single-port, AC input
Order number **NPD-6001C | F.01U.398.266**

MSD-064G IP SECURITY MICROSD CARD 64GB

64 GB industrial microSD card with health status monitoring

Order number **MSD-064G | F.01U.394.680**

MSD-128G IP SECURITY MICROSD CARD 128GB

128 GB industrial microSD card with health status monitoring

Order number **MSD-128G | F.01U.394.681**

MSD-256G IP SECURITY MICROSD CARD 256GB

256 GB industrial microSD card with health status monitoring

Order number **MSD-256G | F.01U.394.682**

NCA-WLAN-EU Wireless installation dongle EU

Wireless installation dongle for wireless commissioning

Order number **NCA-WLAN-EU | F.01U.405.793**

NCA-WLAN-NA Wireless installation dongle NA

Wireless installation dongle for wireless commissioning for North America

Order number **NCA-WLAN-NA | F.01U.405.794**

Represented by:**Europe, Middle East, Africa:**

Bosch Security Systems B.V.
P.O. Box 80002
5600 JB Eindhoven, The Netherlands
Phone: + 31 40 2577 284
www.boschsecurity.com/xc/en/contact/
www.boschsecurity.com

Germany:

Bosch Sicherheitssysteme GmbH
Robert-Bosch-Ring 5
85630 Grasbrunn
Tel.: +49 (0)89 6290 0
Fax: +49 (0)89 6290 1020
de.securitysystems@bosch.com
www.boschsecurity.com

North America:

Bosch Security Systems, LLC
130 Perinton Parkway
Fairport, New York, 14450, USA
Phone: +1 800 289 0096
Fax: +1 585 223 9180
onlinehelp@us.bosch.com
www.boschsecurity.com

Asia-Pacific:

Robert Bosch (SEA) Pte Ltd, Security Systems
11 Bishan Street 21
Singapore 573943
Phone: +65 6571 2808
Fax: +65 6571 2699
www.boschsecurity.com/xc/en/contact/
www.boschsecurity.com