

## NDS-5703-F360 Fixed dome 6MP 360°

### FLEXIDOME panoramic 5100i



- ▶ 360° panoramic overview in 6MP resolution without blind spots
- ▶ High Dynamic Range to see every detail in both bright and dark areas of the scene
- ▶ Edge or client-side dewarping for easy integration and flexible viewing and recording
- ▶ Built-in Intelligent Video Analytics and Intelligent Audio Analytics to trigger relevant alerts and quickly retrieve data
- ▶ Compact design for unobtrusive indoor use with quick and easy installation and set-up

The NDS-5703-F360 is a discreet and aesthetic panoramic camera for indoor surveillance without blind spots.

Its stereographic, panoramic lens provides full 360° coverage without blind spots, ideal for surveillance applications that require wide area coverage in a single, detailed view. The camera offers full situational awareness and simultaneous high-resolution zoomed-in images. The high-end system on chip (SoC) provides dewarping for easy integration and flexible viewing and recording.

Built-in Intelligent Video Analytics enriches full situational awareness and triggers relevant alerts. Intelligent Audio Analytics gives meaning to the sounds it captures.

With its HDMI output function, it can be directly connected to a Public View Monitor, making it a perfect fit for a retail environment.

#### Functions

##### 6MP sensor resolution

The camera offers a 6MP sensor to optimize for the amount of details required. This offers 30 fps to ensure real-time motion in your scenes. Together with its stereographic lens the image circle offers a 4.5MP effective resolution.

##### Panoramic vision and Intelligent Video Analytics

Combining Bosch Intelligent Video Analytics software with full panoramic vision, produces an extremely powerful surveillance tool, which enriches full situational awareness. With intelligent tracking, movement can be followed continuously throughout the full image circle. There is no need to hand off tracking from one camera to another, greatly simplifying movement analysis.

The system reliably detects, tracks, and analyzes objects, and alerts you when predefined alarms are triggered. A smart set of alarm rules makes complex tasks easy and reduces false alarms to a minimum. Specifically designed for the most demanding environments. It is extremely resistant to false triggers caused by challenging environments with snow, wind (moving trees), rain, hail, and water reflections. Calibration is quick and easy - just enter the mounting height of the camera. The internal gyro/accelerometer sensor provides the rest of the information to precisely calibrate the video analytics.

##### Camera Trainer

Based on examples of target objects and non-target objects, the Camera Trainer program uses machine learning to allow the user to define objects of interest and generate detectors for them. In contrast to the moving objects that the Intelligent Video Analytics application detects, the Camera Trainer program detects both moving and non-moving objects and

classifies them immediately. Using Configuration Manager, you can configure the Camera Trainer program using both live video as well as recordings available through the respective camera. The resulting detectors can be downloaded and uploaded for distribution to other cameras.

A free of charge license is required to activate the Camera Trainer program.

**Intelligent Audio Analytics**

The device has an integrated microphone array with three digital microphones for Intelligent Audio Analytics. This is a powerful AI-driven audio signal processing algorithm built to detect and identify target sounds from the ambient sound. It is powered by SoundSee technology and developed to improve operations of the International Space Station (ISS). A set of sound detectors identify sound events such as gunshot and T3 / T4 alarms. The sound detectors trigger an alarm functionality to alert the operator when the sound event matches an audio signature of a sound detector. Without the need to record audio, Intelligent Audio Analytics generates metadata that is seamlessly integrated with Bosch’ Intelligent Video Analytics metadata stream.

The device is not only able to classify sounds, but also to provide an approximate location of the sound. If required by local laws, the microphone can be permanently blocked via a secure license key. As Intelligent Audio Analytics is under development, the available Sound Detectors and features will dependent on the camera FW version.

**Dewarping**

The lens captures a circular image. Our dewarping software transforms this circular image into several different distortion-free rectangular views. To facilitate system integration, you can choose edge dewarping inside the camera or client-side dewarping on an external platform.

The edge dewarping in the camera provides three separate video channels simultaneously:

- Full image circle (Video 1 channel)
- Dewarped view mode (Video 2 channel)
- E-PTZ (Video 3 channel)

Different view modes can be selected for the video 2 channel. Your selection depends on the resolution you require and how you wish to view the dewarped image.

**View modes**

The following view modes can be select in the camera or on the client:

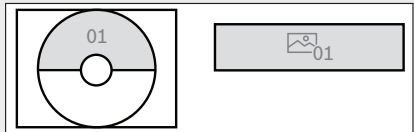
	Full image cut-out and displayed image
Panoramic view (ceiling mount)	

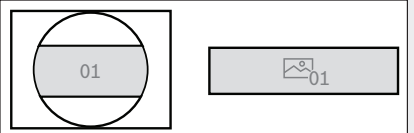
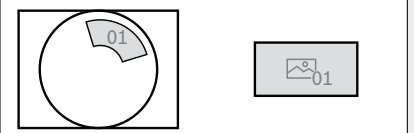
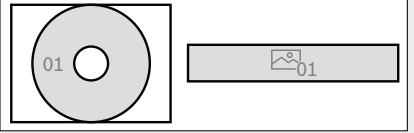
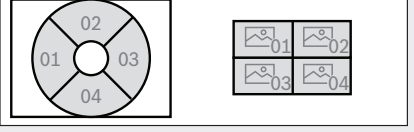
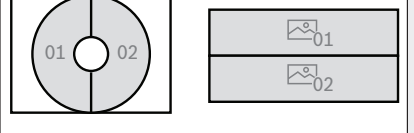
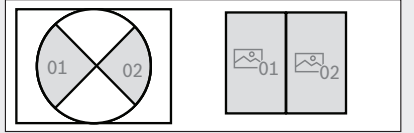
	Full image cut-out and displayed image
Panoramic view (for 180° wall mount)	
E-PTZ view	
Full panoramic view	
Quad view	
Double panoramic view	
Corridor view (ceiling mount)	

**HDMI output**

The camera has HDMI output up to 1080p resolution for live streaming to a public view monitor, ideal for retail usage or for local video display. Via its micro HDMI connector, the camera can display the full image circle.

It also offers the flexibility to display both warped and dewarped images, including quad view and ePTZ.

**High Dynamic Range**

The camera has High Dynamic Range. This is based on a multiple-exposure process that captures more details in the highlights and in the shadows even in the same scene. The result is that you can easily distinguish objects and features, for example, faces with bright backlight.

The actual dynamic range of the camera is measured using Opto-Electronic Conversion Function (OECF) analysis according to IEC 62676 Part 5. This method is used to provide standardized measurements, which can be used to compare different cameras.

**DORI coverage**

DORI (Detect, Observe, Recognize, Identify) is a standard system (EN-62676-4) for defining the ability of a person viewing the video to distinguish persons or objects within a covered area. The maximum distance at which a camera/lens combination can meet these criteria is shown below:

When mounted at 3 m (10 ft) height the camera has the following coverage radius for the four DORI levels for a person in the scene:

DORI	DORI definition	Coverage radius
Detect	25 px/m (8 px/ft)	28 m / 93 ft
Observe	63 px/m (19 px/ft)	11.5 m / 38 ft
Recognize	125 px/m (38 px/ft)	5.5 m / 18 ft
Identify	250 px/m (76 px/ft)	2.1 m / 7 ft

**E-PTZ and regions of interest**

The remote E-PTZ (Electronic Pan, Tilt and Zoom) controls allow you to select specific areas of the full image circle. These Regions of Interest (ROI) can be easily defined, allowing the most interesting part of a scene to be monitored separately. The high resolution ensures that details are not lost even when using the electronic zoom.

The E-PTZ feature of a panoramic camera has some advantages over normal PTZ cameras. There is no camera movement so the camera does not draw attention to itself or appear intrusive. Situational awareness is still retained even when zooming in on a particular object of interest. The smooth E-PTZ function helps navigation, and presets are available for setting up a guard tour.

Intelligent tracking is also available to track people through the entire view of the camera.

**Record exactly what you want**

The camera provides the full resolution circular image for recording even if you are viewing only a portion of the scene. This means that you can always perform retrospective dewarping and analysis on the complete area covered and then zoom in on the region or object of interest.

With edge-dewarping you can also choose to only record the relevant parts of the scene which helps reduce bitrates significantly.

**Scene modes**

The camera has a very intuitive user interface that allows fast and easy configuration. Multiple preset configurable modes are provided with the best settings for a variety of applications. Different scene modes can be selected for different situations, such as sodium lighting or dark environments.

**Edge recording**

Insert a memory card into the card slot to store up to 2 TB of local alarm recording. Pre-alarm recording in RAM reduces recording bandwidth on the network, and extends the effective life of the memory card. It has advanced edge recording providing a reliable storage solution possible due to the combination of these functions:

- Industrial SD card support allows for extreme lifetime
- Health monitoring of industrial SD cards provide early service indications.

Health monitoring will be available with a future firmware version.

**Data security**

Special measures have been put in place to ensure the highest level of security for device access and data transport. The three-level password protection with security recommendations allows users to customize device access. Web browser access can be protected using HTTPS and firmware updates can also be protected with authenticated secure uploads. The cameras have built-in Secure Element (SE) hardware providing main Trusted Platform Module (TPM) functionality to ensure the highest levels of data security and privacy protection. Together with Public Key Infrastructure (PKI) support, superior protection from malicious attacks is guaranteed. It also supports

802.1x network authentication with EAP/TLS and RSA encryption key lengths of up to 4096 bits, ensuring data safety beyond 2030. The advanced certificate handling offers:

- Bosch origin device certificate pre-installed
- Self-signed unique certificates automatically created when required
- Client and server certificates for authentication
- Client certificates for proof of authenticity
- Certificates with encrypted private keys

#### Modular accessories

A full line of modular accessories is available that allows a consistent design across different cameras and a wide range of installation possibilities. Available options include wall or pipe mount, a surveillance cabinet with power and fiber optic options, and an in-ceiling mounting kit.

#### H.265 high-efficiency video encoding

The camera is designed on the most efficient and powerful H.264 and H.265/HEVC encoding platform. The camera is capable of delivering high-quality and high-resolution video with very low network load. With a doubling of encoding efficiency, H.265 is the compression standard of choice for IP video surveillance systems.

#### System integration and ONVIF conformance

The camera conforms to the ONVIF Profile S, ONVIF Profile G, ONVIF Profile M, and ONVIF Profile T specifications. For H.265 configuration, the camera supports Media Service 2, which is part of ONVIF Profile T. Compliance with these standards guarantees interoperability between network video products regardless of manufacturer.

Third-party integrators can easily access the internal feature set of the camera for integration into large projects. Visit the Bosch Integration Partner Program (IPP) website ([ipp.boschsecurity.com](http://ipp.boschsecurity.com)) for more information.

#### Cloud-based services

The camera supports time-based or alarm-based JPEG posting to four different accounts. These accounts can address FTP servers or cloud-based storage. Video clips or JPEG images can also be exported to these accounts.

Alarms can be set up to trigger an e-mail or SMS notification so you are always aware of abnormal events.

#### Bosch Remote Portal

With the secure cloud infrastructure, Bosch Remote Portal, you can manage your connected Bosch devices. From the Bosch Remote Portal you can:

- Complete initial configuration of your connected Bosch devices (online or offline).

- Update firmware for single or multiple devices.
- Manage certificates.
- Monitor the health of your connected Bosch devices.

#### Regulatory information

Standards	Type
Emission	EN 55032 EN 50121-4 CFR 47 FCC part 15, Class A
Environmental	EN IEC 63000: 2018 EN 50130-5: 2011 RoHS EU, 2011/65/EU and 2015/863/EU WEEE EU, 2012/19/EU
Immunity	EN 50130-4
Marks	CE, FCC, UL, WEEE, RCM, VCCI, CMIM, UKCA, China RoHS, BIS
Safety	EN 62368-1 UL 62368-1, 2nd edition CAN/CSA-C 22.2 No. 62368-1-14, 2nd edition
Image performance	IEC 62676-5
ONVIF conformance	EN 50132-5-2, EN 62676-2

Region	Regulatory compliance/quality marks	
Great Britain	UKCA	
USA	UL-CAP	Cybersecurity Assurance Program
Global	IEC_62443	Industrial Cyber Security Capability
Europe	CE	

## Installation/configuration notes

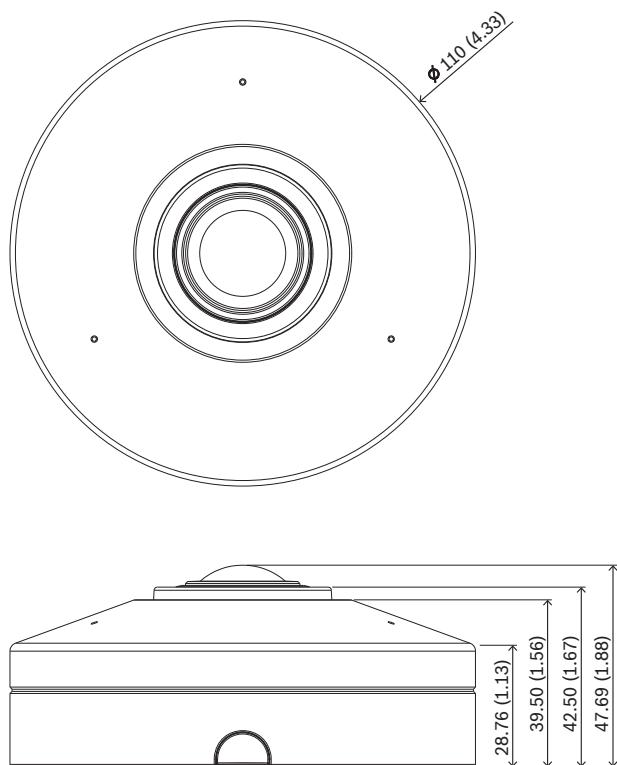

Dimensions in mm (inch)

## Parts included

Quantity	Component
1	Camera base
1	Camera cover
1	TR15 Allen key for microSD slot lock
1	Quick installation guide
1	Safety information
3	Installer UX labels

## Technical specifications

Power	
Input voltage	PoE IEEE 802.3af Type 1, Class 2
Power consumption (typical / maximum)	PoE: 5.6 / 6 W
Sensor	
Total sensor pixels	6 MP
Type	1/1.8-inch CMOS

Sensor		
Used pixels	2112 x 2112 (4.5 MP)	
Video performance - Sensitivity		
Measured according to IEC 62676 Part 5 (1/25, F2.0)		
Color	0.099 lx	
Mono	0.008 lx	
Video performance - Dynamic range		
Wide Dynamic Range	120 dB WDR	
Measured according to IEC 62676 Part 5	105 dB WDR	
Video streaming		
Video compression	H.265; H.264; M-JPEG	
Streaming	Multiple configurable streams in H.265, H.264 and M-JPEG, configurable frame rate and bandwidth. Multiple channels with edge dewarping. Regions of Interest (ROI)	
Overall IP Delay	Min. 120 ms, Max. 340 ms	
GOP structure	IP, IBP, IBBP	
Frame rate (6 MP)	1-30fps	
Encoder regions	Eight independent areas for setting encoder quality to optimize bitrate.	
Video resolution (H x V)		
Video 1 channel	Full image circle	2112 x 2112 (4.5 MP)
Video 2 channel	Various dewarped modes (Full panoramic, double panoramic, quad, corridor, E-PTZ)	Resolution depends on selected dewarped mode
Video 3 channel	E-PTZ	Up to 1920 x 1080
Multiple lower resolutions available and individually selectable per channel and stream		
Video functions		
Day/Night	Color, Monochrome, Auto (adjustable switchover points)	
Adjustable picture settings	Contrast, Saturation level and control, Brightness, Sharpness	

Video functions	
White Balance	2500 to 10000K, 3 automatic modes (Basic, Standard, Sodium vapor), Manual mode and Hold mode
Shutter	Automatic Electronic Shutter (AES) Default shutter (1/30 [1/25] to 1/500) selectable Max. shutter speed 1/1.875 to 1/150000
Backlight compensation	Off / On
Noise reduction	Dynamic Noise Reduction
Privacy masking	Eight independent areas, fully programmable
Scene modes	Multiple default modes with scheduler
Pre-positions	Six independent sectors
Guard tours	Pre-position tour consisting of up to six scenes, consecutively
Display stamping	Individual names and stamps for all video channels
Other functions	Pixel counter, Video watermarking, Location
Video content analysis	
Analysis type	Intelligent Video Analytics, Camera Trainer
Alarm rules (combinable)	Any object, Object in field, Line crossing, Enter / leave field, Loitering, Follow route, Idle / removed object, Counting, Occupancy, Crowd density estimation, Condition change, Similarity search, Flow / counter flow
Object filters	Duration, Size, Aspect ratio, Speed, Direction, Color, Object classes (4)
Tracking modes	Standard (2D) tracking, 3D tracking, 3D people tracking, Ship tracking, Museum mode
Object classes	Person, car, bike, truck
Calibration / Geolocation	Automatic, based on gyro sensor and camera height
Intelligent Audio Analytics	Gunshot detection, T3 / T4 alarm detection (licensed). More detectors will be available with future releases.
Optical	
Lens	1.155 mm fixed-focus lens F2.0
Lens mount	Board mounted

Optical	
Iris control	Fixed iris
Day/Night	Switchable IR-cut filter
Field of view	182° (H) x 182° (V)
Minimum object distance	0.1 m
Local storage	
Internal RAM	5 s pre-alarm recording
Memory card slot	Micro SDXC / SDHC / SD card
Industrial SD cards	Extreme lifetime and health monitoring support (if supported by the SD card) that provides early service indication.
Input/output	
HDMI output	Micro HDMI connector and up to 1080p resolution with dewarped viewing possibilities
Microphone	Integrated array with 3 digital MEMS audio sensors
Ethernet	RJ-45
Audio streaming	
Standard	G.711, 8 kHz sampling rate L16, 16 kHz sampling rate AAC-LC, 96 kbps at 32/48 kHz sampling rate
Signal-to-Noise Ratio	>50 dB
Audio Streaming	Full-duplex / half duplex
Platform	
Common product platform	CPP14
Data security	
Secure Element ("TPM")	RSA 4096 bit, AES/CBC 256 bit
PKI	X.509 certificates
Encryption	Full end-to-end encryption with supported VMS Network: TLS1.0/1.1/1.2/1.3, AES128, AES256 Local storage: XTS-AES
Video authentication	Checksum, MD5, SHA-1, SHA-256

Data security	
Firmware protection	Signed firmware, secure boot
Network	
Protocols	IPv4, IPv6, UDP, TCP, HTTP, HTTPS, RTP/RTCP, IGMP V2/V3, ICMP, ICMPv6, RTSP, FTP, ARP, DHCP, APIPA (Auto-IP, link local address), NTP (SNTP), SNMP (V1, V3, MIB-II), 802.1x, DNS, DNSv6, DDNS (DynDNS.org, selfHOST.de, no-ip.com), SMTP, iSCSI, UPnP (SSDP), Diff-Serv (QoS), LLDP, SOAP, CHAP, digest authentication
Ethernet	10/100/1000 Base-T, auto-sensing, half/full duplex
Connectivity	Auto-MDIX
Interoperability	ONVIF Profile S ONVIF Profile G ONVIF Profile M ONVIF Profile T
Mechanical	
Dimensions (∅ x H)	110 x 47.7 mm (4.33 x 1.88 in)
Lens adjustment (rotation)	355°
Weight	0.31 kg (0.68 lbs)
Color	White (RAL9003)
Gyrosensor	Yes
Mounting	Surface mount
Environmental	
Operating temperature	-10 °C to +45 °C (14 °F to 113 °F) Cold start temperature 0 °C (32 °F)
Storage temperature	-40 °C to +70 °C (-40 °F to 158 °F)
Operating humidity	5% to 93% RH non-condensing 5% to 100% RH condensing
Storage humidity	Up to 98% RH
Impact protection	IK08 (except lens)
Sustainability	PVC free
Country of origin	Thailand

## Ordering information

### NDS-5703-F360 Fixed dome 6MP 360°

360° 6MP panoramic camera with HDR, IVA, microphone array for Intelligent Audio Analytics, H.265  
NDAA compliant  
Order number **NDS-5703-F360 | F.01U.385.628**

## Accessories

### NDA-5081-PIP Pendant interface plate, 110mm

Pendant interface plate for the FLEXIDOME IP micro 3000i and the FLEXIDOME panoramic 5100i families  
Order number **NDA-5081-PIP | F.01U.391.131**

### NDA-U-WMT Pendant wall mount

Universal wall mount for dome cameras, white  
Order number **NDA-U-WMT | F.01U.324.939**

### NDA-U-WMP Wall mount plate

Back plate for universal wall mount, corner mount and pole mount, white, IP66  
Order number **NDA-U-WMP | F.01U.324.950**

### NDA-U-PMT Pendant pipe mount, 12" (31cm)

Universal pipe mount for dome cameras, 31 cm, white  
Order number **NDA-U-PMT | F.01U.324.940**

### NDA-U-PMTE Pendant pipe extension, 20" (50cm)

Extension for universal pipe mount, 50 cm, white  
Order number **NDA-U-PMTE | F.01U.324.941**

### NDA-U-PMTS Pendant pipe mount, 4" (11 cm)

Universal pendant pipe mount for dome cameras, 11 cm (4"), white  
Order number **NDA-U-PMTS | F.01U.385.046**

### NDA-U-PSMB Pendant wall/ceiling mount SMB

Surface mount box (SMB) for wall mount or pipe mount.  
Order number **NDA-U-PSMB | F.01U.324.942**

### NDA-U-PMAS Pole mount adapter small

Pole mount adapter small  
Universal pole mount adapter, white; small.  
Order number **NDA-U-PMAS | F.01U.324.943**

### NDA-U-PMAL Pole mount adapter large

Universal pole mount adapter, white; large  
Order number **NDA-U-PMAL | F.01U.324.944**

### NDA-5081-PC Paintable cover, F360, 4pcs

Paintable cover for FLEXIDOME panoramic 5100i  
Order number **NDA-5081-PC | F.01U.394.005**

### NDA-5081-TM Tilt mount 20°, 110mm

Tilt mount (20°) for FLEXIDOME panoramic 5100i indoor  
Order number **NDA-5081-TM | F.01U.391.130**

### NDA-5081-PLEN In-ceiling plenum rated kit, 110mm

Plenum-rated in-ceiling mount kit for FLEXIDOME panoramic 5100i and FLEXIDOME IP micro 3000i  
Order number **NDA-5081-PLEN | F.01U.394.002**

### NDA-U-CMT Corner mount adapter

Universal corner mount, white  
Order number **NDA-U-CMT | F.01U.324.946**

### NDA-U-PMTG Pendant pipe mount, gang box

Universal pipe mount, compatible with gang box installation for fixed dome cameras only, white  
Order number **NDA-U-PMTG | F.01U.358.359**

**NDA-U-WMTG Pendant wall mount, gang box**

Universal wall mount, compatible with gang box installation for fixed dome cameras only, white  
Order number **NDA-U-WMTG | F.01U.358.358**

**NDA-3081-4S 4S adapter plate, 171mm**

4S adapter plate for NDV-3000 micro dome camera  
Order number **NDA-3081-4S | F.01U.379.490**  
**F.01U.396.507**

**NPD-3001-WAP Portable installation tool**

Bosch camera portable and wireless installation tool  
Order number **NPD-3001-WAP | F.01U.353.329**

**NPD-5001-POE Midspan, 15W, single port, AC in**

Power-over-Ethernet midspan injector for use with PoE enabled cameras; 15.4 W, 1-port  
Weight: 200 g (0.44 lb)  
Order number **NPD-5001-POE | F.01U.305.288**

**NPD-5004-POE Midspan, 4 port x 15W, AC in**

Power-over-Ethernet midspan injector for use with PoE enabled cameras; 15.4 W, 4-ports  
Weight: 620 g (1.4 lb)  
Order number **NPD-5004-POE | F.01U.305.289**

**MSD-064G IP SECURITY MICROSD CARD 64GB**

64 GB industrial microSD card with health status monitoring  
Order number **MSD-064G | F.01U.394.680**

**MSD-128G IP SECURITY MICROSD CARD 128GB**

128 GB industrial microSD card with health status monitoring  
Order number **MSD-128G | F.01U.394.681**

**MSD-256G IP SECURITY MICROSD CARD 256GB**

256 GB industrial microSD card with health status monitoring  
Order number **MSD-256G | F.01U.394.682**

**Software Options****MVC-IAA-TRIAL Trial License, 60-day**

Trial License, 60-day  
Order number **MVC-IAA-TRIAL | F.01U.412.669**

**MVC-IAA-GUN1Y Gunshot Detector License, 1-year**

Gunshot Detector License, 1-year  
Order number **MVC-IAA-GUN1Y | F.01U.412.670**

**MVC-IAA-GUN3Y Gunshot Detector License, 3-year**

Gunshot Detector License, 3-year  
Order number **MVC-IAA-GUN3Y | F.01U.412.671**

**MVC-IAA-GUN5Y Gunshot Detector License, 5-year**

Gunshot Detector License, 5-year  
Order number **MVC-IAA-GUN5Y | F.01U.412.672**

**MVC-IAA-GUN Gunshot Detector License, perpetual**

Gunshot Detector License, perpetual  
Order number **MVC-IAA-GUN | F.01U.412.673**

**Represented by:**

**Europe, Middle East, Africa:**  
Bosch Security Systems B.V.  
P.O. Box 80002  
5600 JB Eindhoven, The Netherlands  
Phone: +31 40 2577 284  
[www.boschsecurity.com/xc/en/contact/](http://www.boschsecurity.com/xc/en/contact/)  
[www.boschsecurity.com](http://www.boschsecurity.com)

**Germany:**  
Bosch Sicherheitssysteme GmbH  
Robert-Bosch-Ring 5  
85630 Grasbrunn  
Tel.: +49 (0)89 6290 0  
Fax: +49 (0)89 6290 1020  
[de.securitysystems@bosch.com](mailto:de.securitysystems@bosch.com)  
[www.boschsecurity.com](http://www.boschsecurity.com)

**North America:**  
Bosch Security Systems, LLC  
130 Perinton Parkway  
Fairport, New York, 14450, USA  
Phone: +1 800 289 0096  
Fax: +1 585 223 9180  
[onlinehelp@us.bosch.com](mailto:onlinehelp@us.bosch.com)  
[www.boschsecurity.com](http://www.boschsecurity.com)

**Asia-Pacific:**  
Robert Bosch (SEA) Pte Ltd, Security Systems  
11 Bishan Street 21  
Singapore 573943  
Phone: +65 6571 2808  
Fax: +65 6571 2699  
[www.boschsecurity.com/xc/en/contact/](http://www.boschsecurity.com/xc/en/contact/)  
[www.boschsecurity.com](http://www.boschsecurity.com)