

DISTRIBUTED BY



madison
Technologies

KEEP MINING KEEP MOVING

Industrial Communication and Computing
Solutions for Mining Digitalization

MOXA

The mining industry is at yet another crossroads in its hundreds of years of history. To stay profitable amidst technology changes, the industry is embracing automation, unmanned operations, and decarbonization. At the same time, it must confront a multitude of internal and external challenges.

The Ever-changing Landscape in the Mining Industry

Internal Challenges

Changing terrains-
mining deeper underground,
digging farther into mountains

Changing conditions-
flooding, toxic gases, explosions,
mine collapses

Changing technologies-
automation, remote controlling,
decarbonization

External Challenges

Evolving cyberthreats-
As mining equipment gets
connected, cyberthreats are not
affecting IT only but also OT

Evolving energy diversity-
Embracing net zero calls for renewable
energy and more complex grid
management

Evolving mining commodity selection-
Fast deployment and adjustments to
absorb market fluctuations in mineral
demand

Embrace Changes with Advanced Automation Networks - Let Moxa Help Keep You Moving Forward.

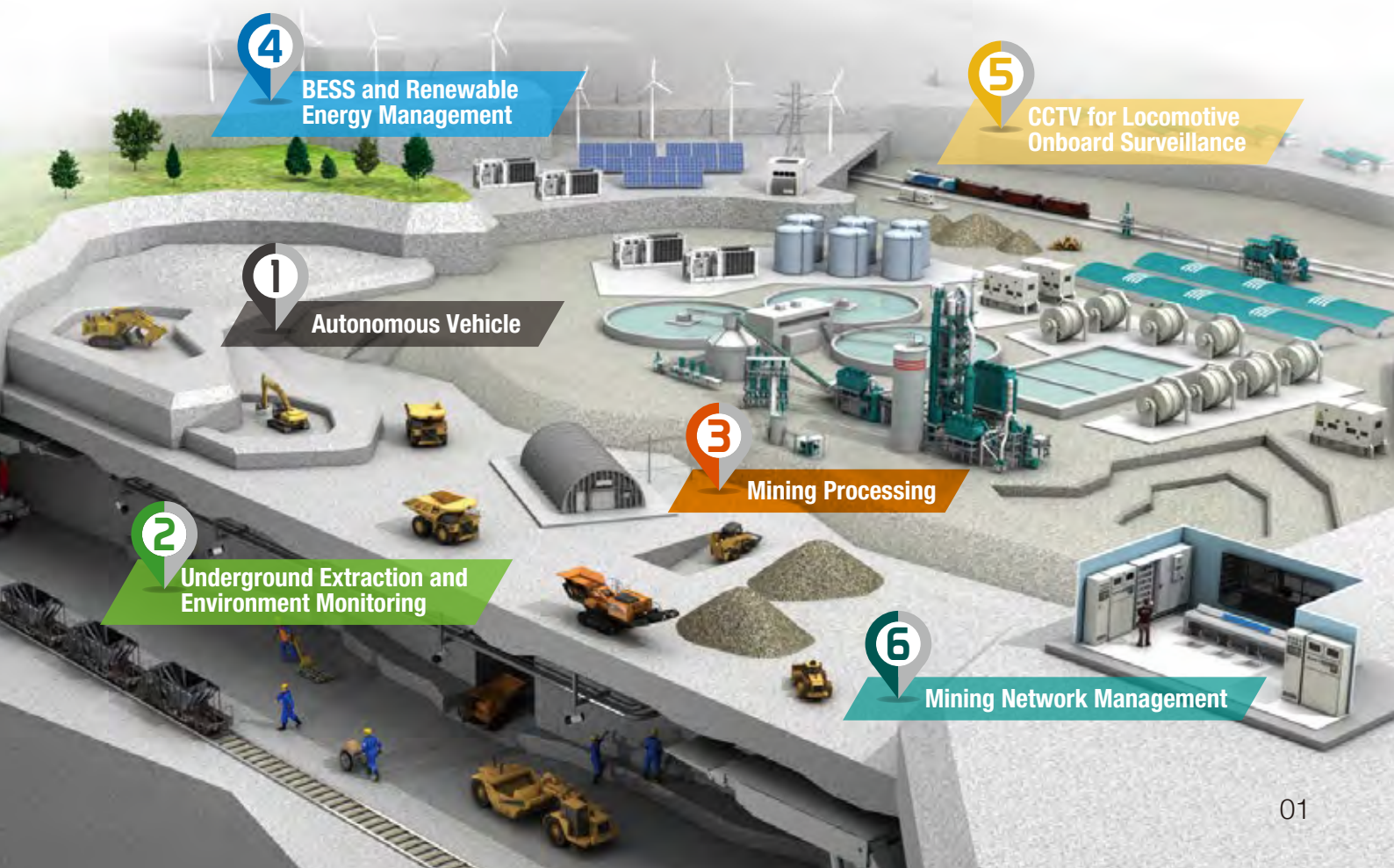

Network Architecture of Mining Automation

Site Operation Center Mining Network Management



Local SCADA

Boost Your Backbone Scalability



MRX-G4064
10GbE Layer 3 Full
Gigabit Switch



MXview One
Network Management
Software



MXsecurity
Network Security
Management Software

page 8

page 3

Extraction

Communication Networks of Autonomous Vehicle

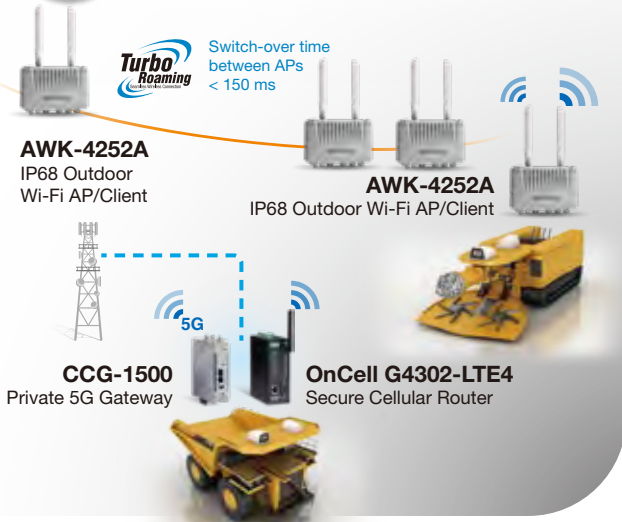

Process Plant

Process Control System Networks

page 5

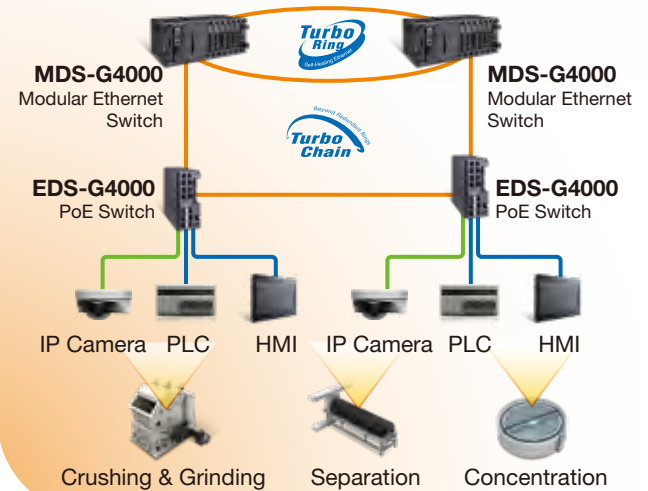

page 6

Substation

PRP/HSR Networks for IEC 61850 Substations

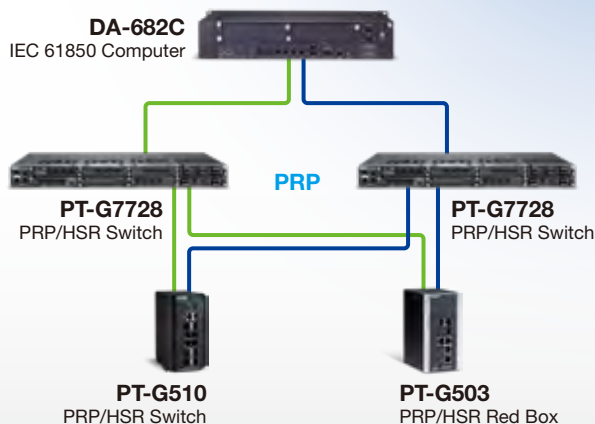

Renewable Energy

Secure Access for BESS Monitoring

page 6

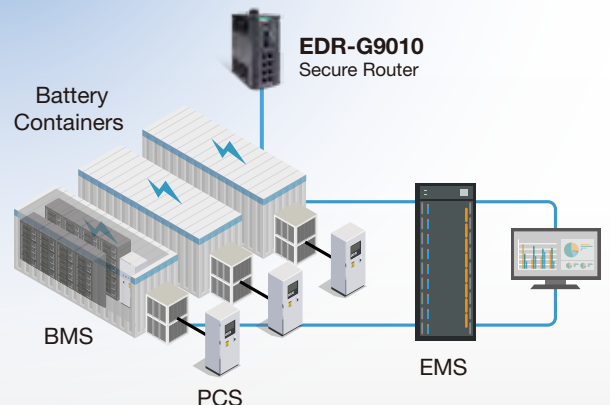

Moxa facilitates agile responses to diverse changes in the mining industry

Be Agile Today:

> Availability

From wired and wireless connectivity to high bandwidth, advanced redundancy, and roaming capabilities for industrial networks

> Visibility

Full visibility of wired and wireless devices from field sites to remote control centers

> Interoperability

Multiple protocols and edge computing fulfill OT/IT data convergence

Be Agile for the Future:

> Cybersecurity

Strengthen cybersecurity in OT networks and comply with IEC 62443 for IT/OT convergence

> Energy Diversity

From renewable energy, energy storage to smart grids and microgrids, we are experts in critical infrastructure, empowering sustainable and hybrid power supply through stable communication



Communication Networks of Autonomous Vehicle

Autonomous Mining Trucks

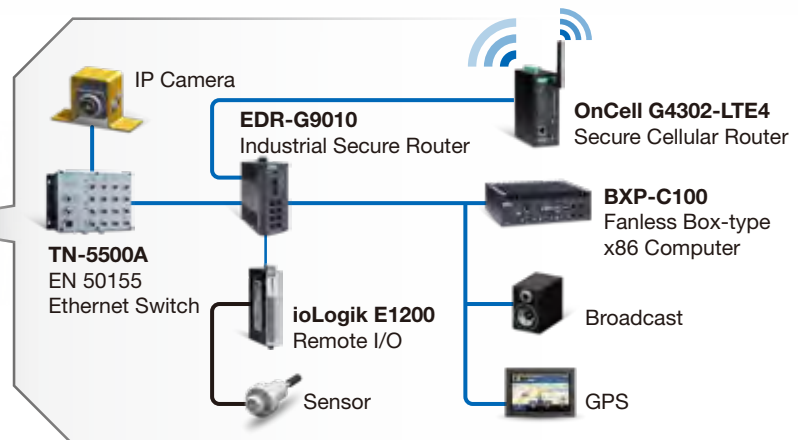

- Ethernet
- Gigabit
- I/O Signal



Turbo Roaming
Switch-over time
between APs
< 150 ms

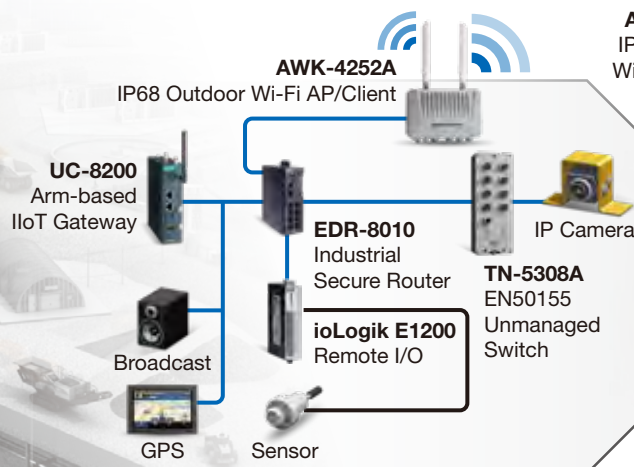

Underground Driverless Trucks



Robust Backbone Network for Underground Extraction and Environment Monitoring

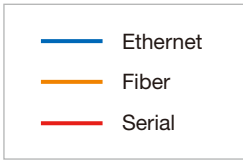

Remote Control Center

Tunnel Safety Monitoring System

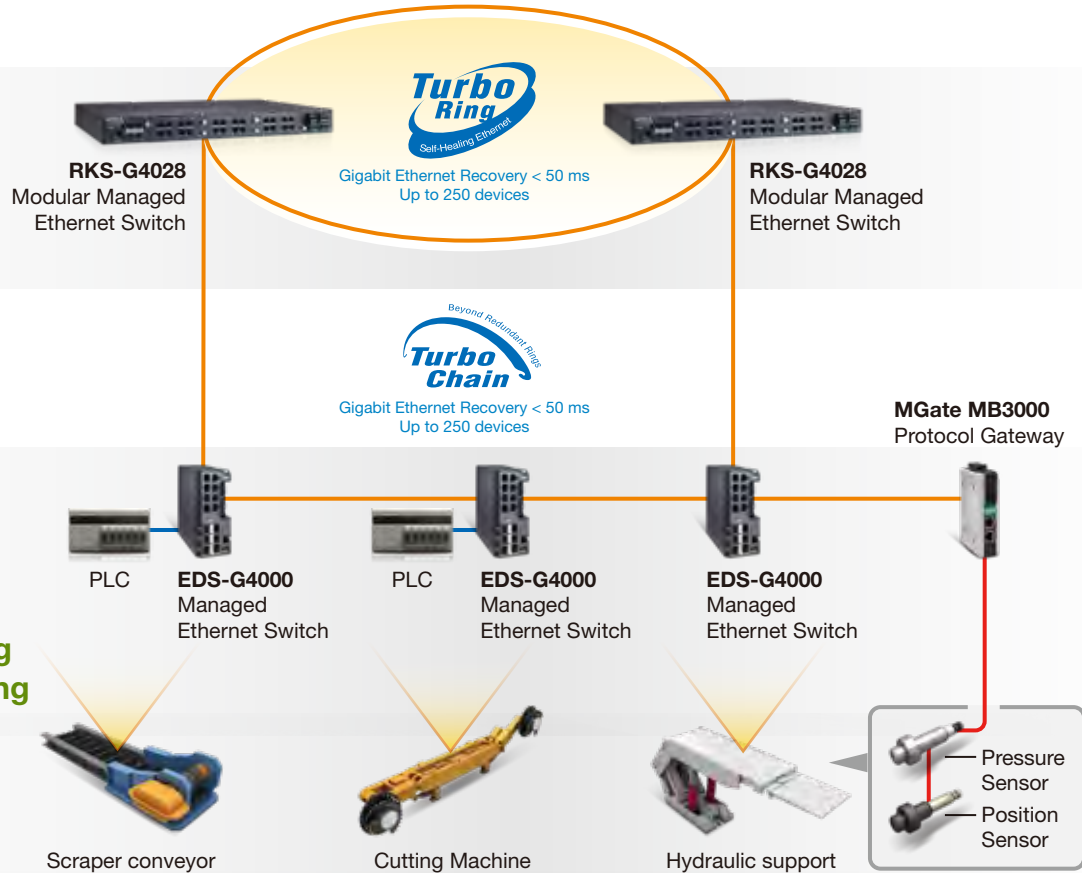

Underground Mining Extraction Monitoring

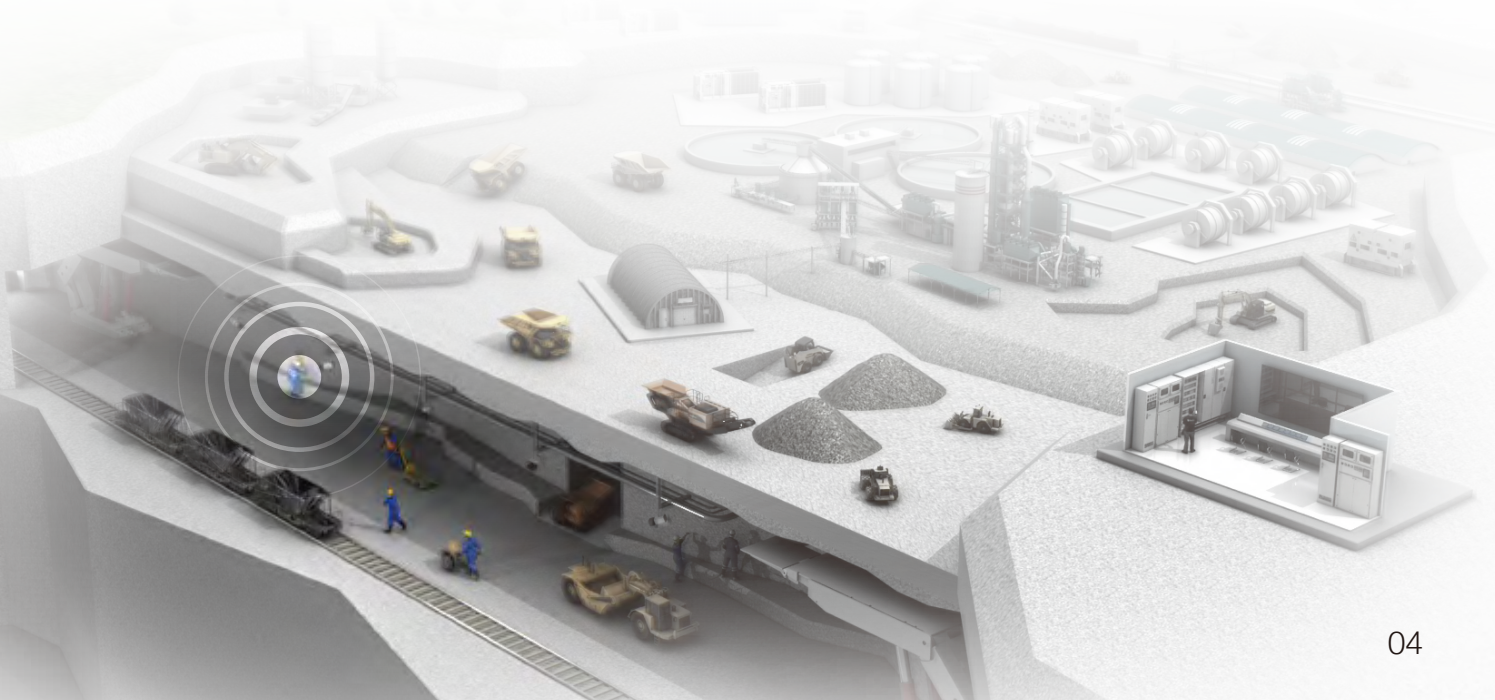



Processing Control System Networks

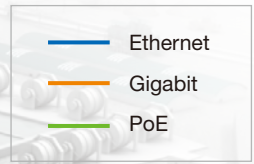
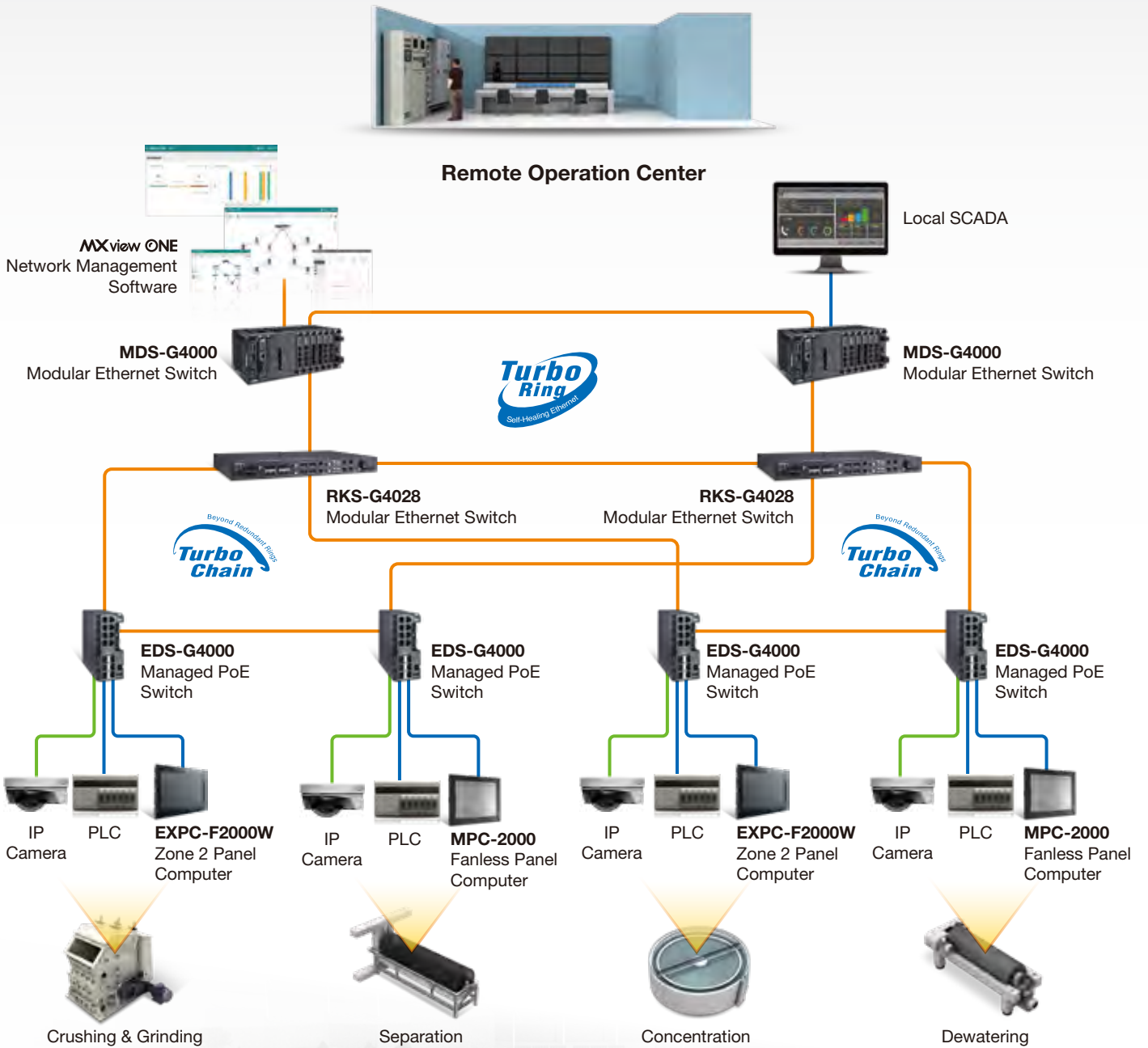



Accelerate Clean Energy Transition With Resilient Communication Networks

Moxa's Solutions for Grid-connected Battery Energy Storage Systems

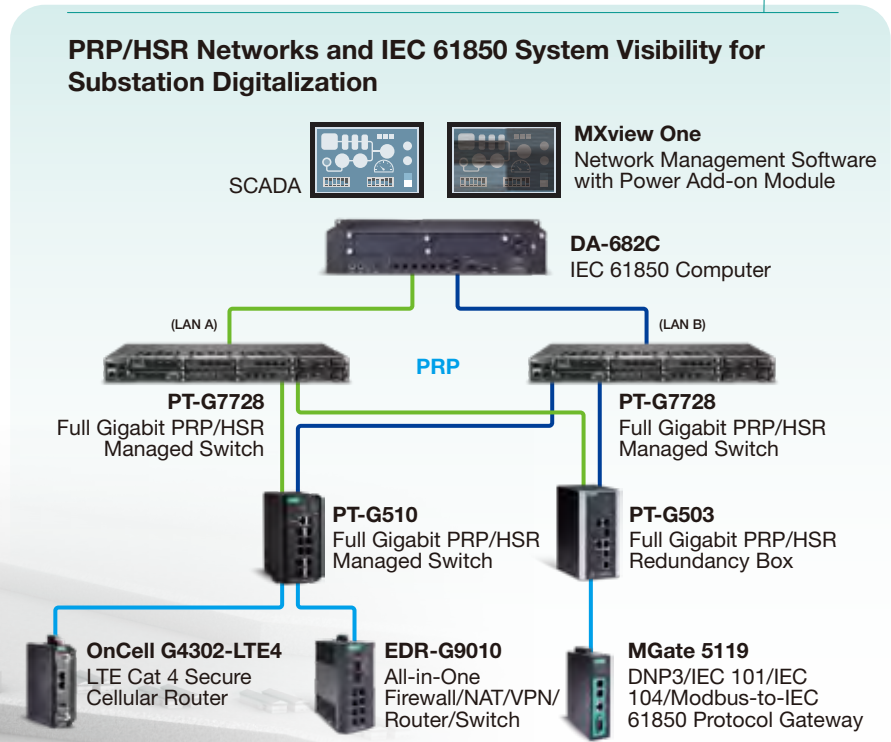
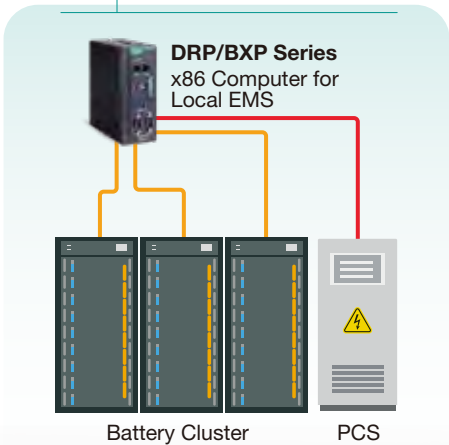
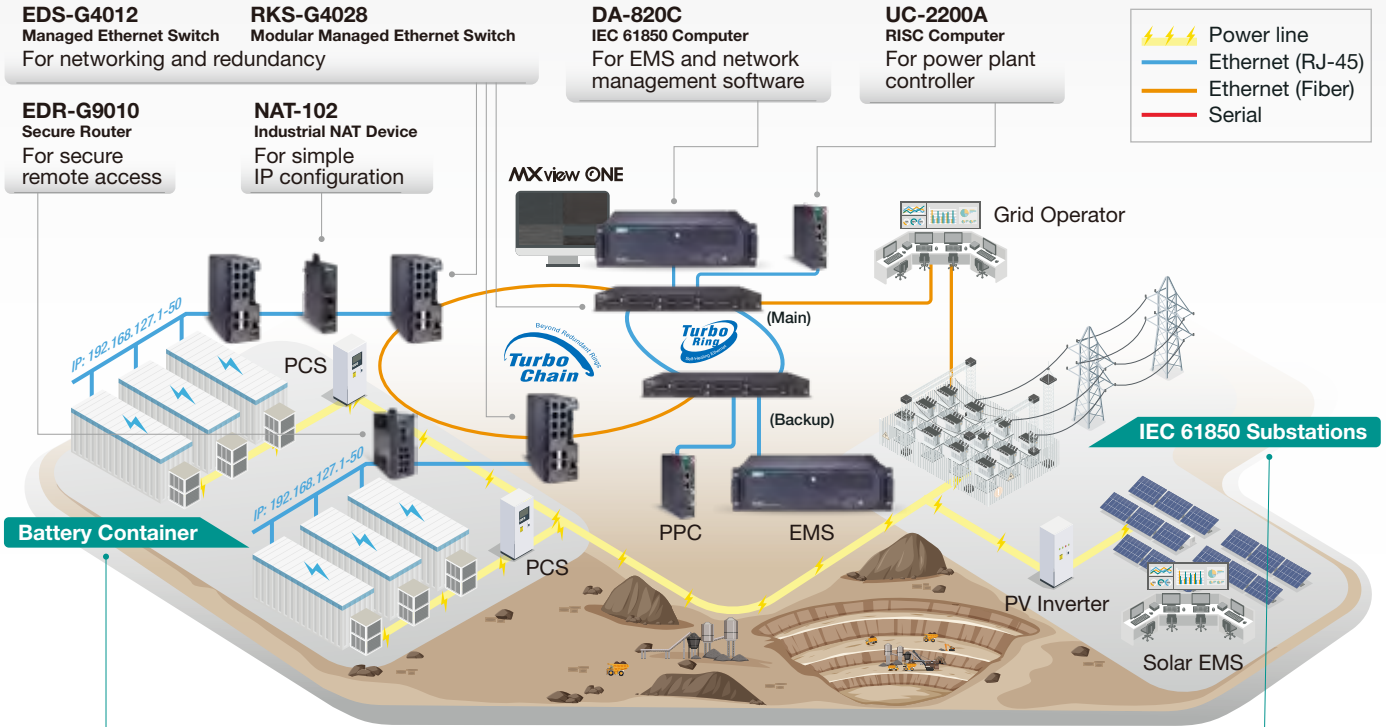



CCTV for Locomotive Onboard Surveillance

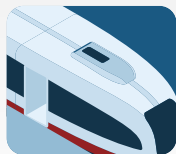

Forward-/Rear-facing Camera

VPort P16-1MP-M12
EN 50155 720P
Rugged IP Camera

Driver Cabin Camera

VPort P16-1MP-M12-IR
EN 50155 720P Infrared
IP Camera

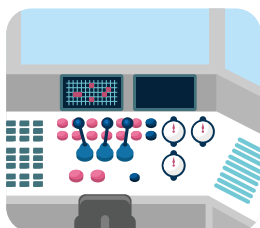

TN-G6512
EN 50155 M12 Gigabit
PoE Switch



MPC-2101/2121
EN 50155 10/12-inch
x86 Panel Computer



V2406C
EN 50155
x86 NVR Computer

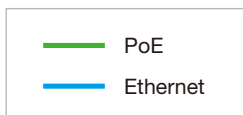



Mining Network Management

MXview One

Efficient Daily Operation



Network Status At a Glance



Flash Backup and Restore



Timely Notification



OT/IT Convergence Made Easy

MXsecurity

Enhanced Cybersecurity Protection



Firewall



IPS



DPI



VPN



NAT



Visibility on Malicious Activities



Unified Security Policy



Real-time Alert



Centralized Management



Operation Center

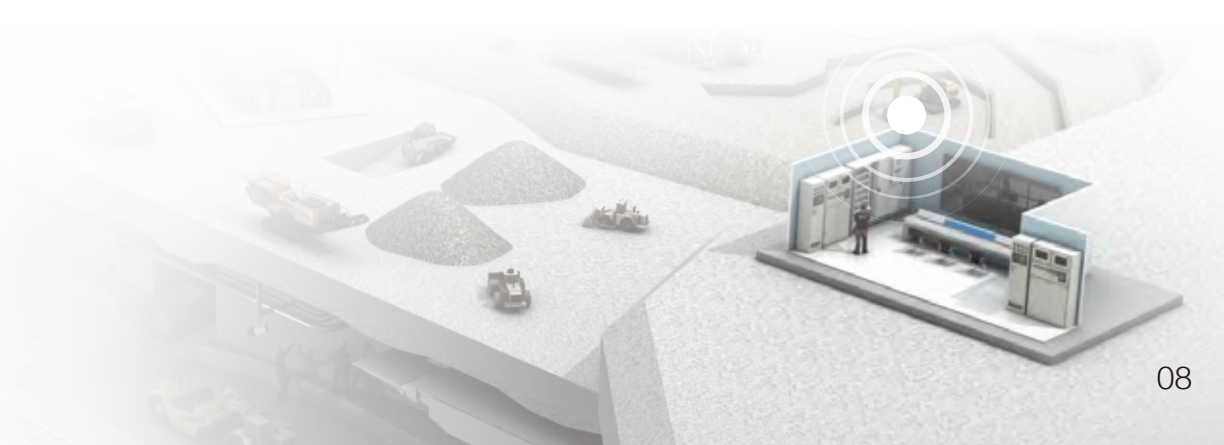

Your One-stop Shop: Addressing Diverse Connectivity Needs in One Go

Ethernet Switches/PoE Switches

Support Turbo Ring, Turbo Chain, STP/RSTP/MSTP for network redundancy, and provide PoE/PoE+/PoE++ options



Rackmount/Modular/ Din-rail Switches

MRX-G4064 **NEW**
RKS-G4028
MDS-G4000
EDS-4000/G4000



EN 50155 Switches

TN Series

IEC 61850 Switches

PT-G7728/G7828
PT-G510/G503

Industrial Computers



Fanless x86 Computers **NEW**

11th Gen Intel® Core™ Processors
DRP-A100/C100
BXP-A100/C100
RKP-A110/C110
EN 50155 Certified
V2403C/2406C



IEC 61850 Certified

DA-820C/682C/681C

Fanless Panel PC **NEW**

Zone 2 Certified
MPC-3000
EXPC-F2000W

Industrial Wireless



Private 5G Cellular Gateways **NEW**

CCG-1500

Cellular Routers **NEW**

OnCell G4302-LTE4

Outdoor 802.11ac AP/Client

AWK-4252A

Outdoor 802.11ax AP/Client **Coming Soon**

AWK-4262A

Secure Routers



All-in-One

Firewall/NAT/VPN/Router/Switch

EDR-G9010/G9004/8010

Next-generation LAN Firewalls **NEW**

EDF-G1002-BP

Industrial Network Address Translation (NAT) Devices

NAT-102

Industrial IoT Gateways

4G, MQTT, built-in device SDKs for Azure/AWS cloud, Moxa Industrial Linux 10-year support



Arm-based Computers

UC-5100/8200/1200A/2200A
AIG-101/301/302

Network Management



Network Management Software

MXview One with Power/Wireless
Added-on Modules



Network Security Management Software

MXsecurity

Protocol Gateways



MGate MB3000
MGate 5000

Remote I/O



Modular/Standalone

ioThinX 4510
ioLogik E1200

IP Cameras



EN 50155 Certified

VPort Series

Your Trusted Partner in Automation

Moxa is a leading provider of edge connectivity, industrial computing, and network infrastructure solutions for enabling connectivity for the Industrial Internet of Things (IIoT). With over 35 years of industry experience, Moxa has connected more than 102 million devices worldwide and has a distribution and service network that reaches customers in more than 85 countries. Moxa delivers lasting business value by empowering industries with reliable networks and sincere service. Information about Moxa's solutions is available at www.moxa.com.

Moxa Americas

USA

Toll Free: 1-888-MOXA-USA
Tel: +1-714-528-6777
Fax: +1-714-528-6778
usa@moxa.com

Brazil

Tel: +55-11-95261-6545
brazil@moxa.com

Moxa Europe

Tel: +49-89-37003-99-0
Fax: +49-89-37003-99-99
europe@moxa.com

Moxa Asia-Pacific and Taiwan

Asia/Taiwan

Tel: +886-2-8919-1230
Fax: +886-2-8522-8623
asia@moxa.com
taiwan@moxa.com

India

Tel: +91-80-4172-9088
Fax: +91-80-4132-1045
india@moxa.com

Korea

Tel: +82-2-6268-4048
Fax: +82-2-6268-4044
korea@moxa.com

Japan

Tel: +81-3-6721-5670
Fax: +81-3-6721-5671
japan@moxa.com

Moxa China

Shanghai

Tel: +86-21-5258-9955
Fax: +86-21-5258-5505
china@moxa.com

Beijing

Tel: +86-10-5976-6123/24/25/26
Fax: +86-10-5976-6122
china@moxa.com

Shenzhen

Tel: +86-755-8368-4084/94
Fax: +86-755-8368-4148
china@moxa.com



Book the Moxa Demo Ute for a free live demo of our mining solutions!

www.moxa.com/Demo-Ute ◀

MOXA®